

PROACE 2016

TBEL

Update 23/04/16

3 koetswerktypes

3 lengtes met 2 wielbasisen en 2 overhangen

Wielbasis

Overhang
achteraan

short

short

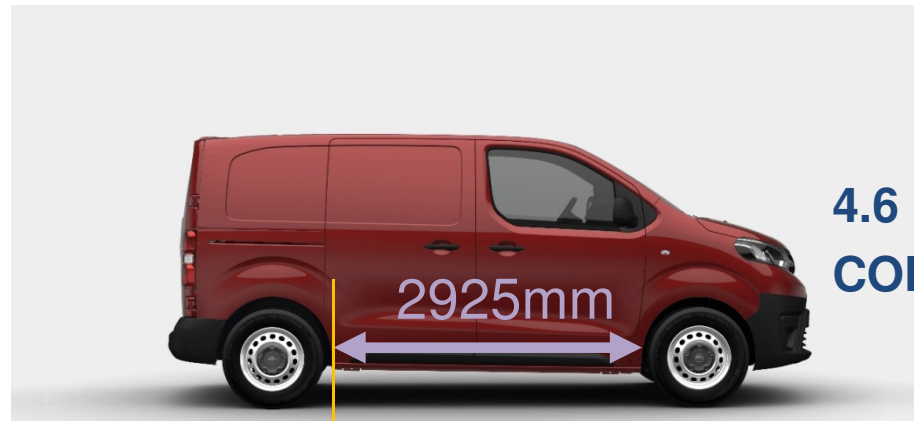

long

short



long

long



Maximale toegelaten massa's



GVW



standard increased



On vans:

- The Long versions are only available with increased GVW.
- The 1.6 D 115 engine comes only with standard payload. For this power level, increased GVW would require a switch to the 2.0 D 120.

	Compact	Medium	Long
1.6 D 95 5MT 70 kW max. GVW determined by engine	2.6 t	2.6 t	-
1.6 D 115 6 MT S&S 85 kW max. GVW determined by engine	2.6 t	2.6 t	-
2.0 D 120 6MT S&S 90 kW max. GVW determined by base	-	3.1 t	3.1 t
2.0 D 150 6MT S&S 110 kW max. GVW determined by base	-	2.7 t	3.1 t
2.0 D 180 6AT S&S 130 kW max. GVW determined by gearbox	-	-	3.0 t

Nuttige ladingen



Payload



standard increased

On vans:

- The Long versions are only available with increased payload.
- The 1.6 D 115 engine comes only with standard payload. For this power level, increased payload would require a switch to the 2.0 D 120.

	Compact		Medium		Long	
1.6 D 95 5MT 70 kW	1000	-	1000	-	-	-
1.6 D 115 6 MT S&S 85 kW	1000	-	1000	-	-	-
2.0 D 120 6MT S&S 90 kW	-	-	-	1400	-	1400
2.0 D 150 6MT S&S 110 kW	-	-	1000	-	-	1400
2.0 D 180 6AT S&S 130 kW	-	-	-	-	-	1250

Laadvolumes

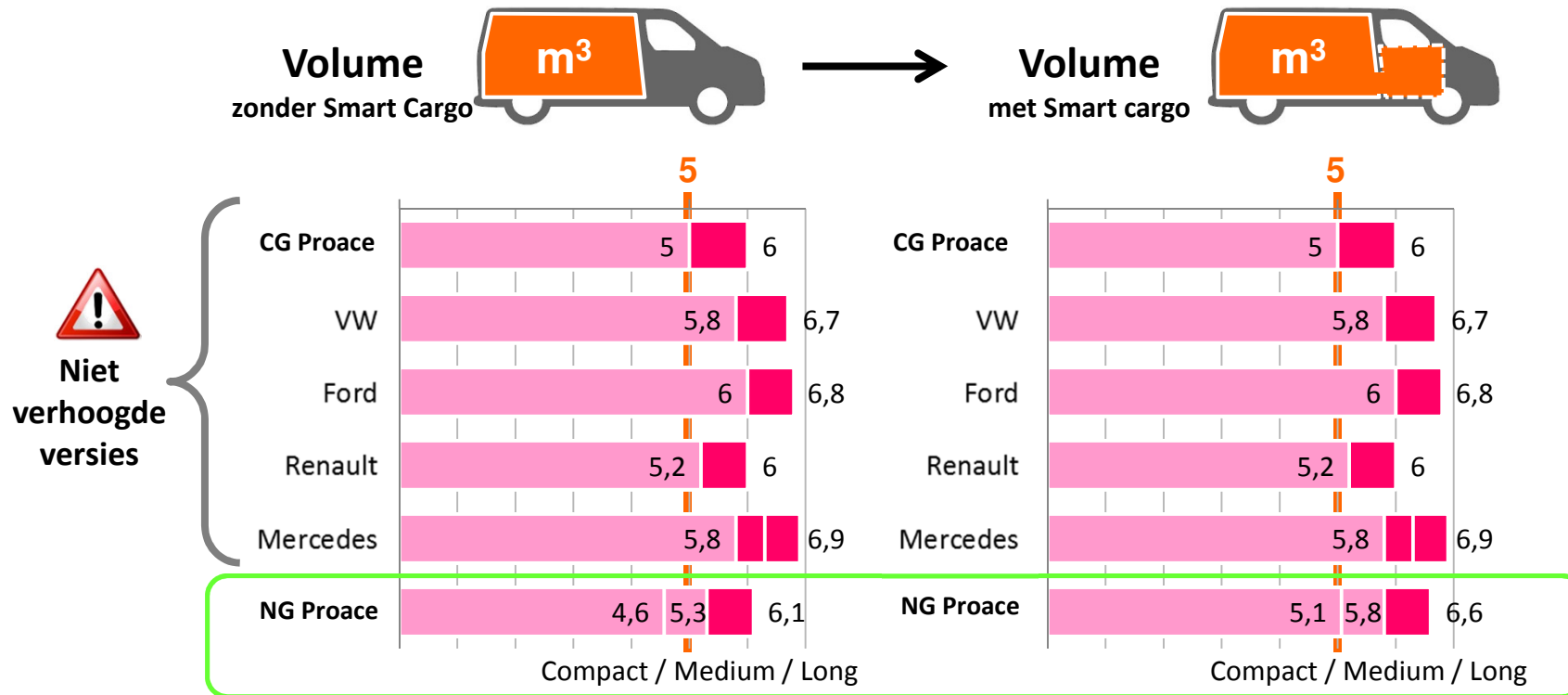

Smart Cargo (op Proace Comfort) biedt 0,5m³ extra volume

Loading volume m ³	without Smart Cargo	with Smart Cargo
Compact	4.6	5.1
Medium	5.3	5.8
Long	6.1	6.6

VAN : Buitenafmetingen



Updated 01/04/2016	NG	NG	CG	NG	CG
Van: afmetingen	Compact	Medium	L1	Long	L2
Buitenafmetingen					
Lengte (van)	4609	4959	4805	5309	5135
Breedte (zonder buitenspiegels)	1920	1920	1895	1920	1895
Breedte met ingeklapte buitenspiegels	2010	2010		2010	
Breedte met buitenspiegels	2204	2204		2204	
Hoogte (1T versie)	1905	1895	1942		1942
Hoogte (1,4T versie)		1930		1935	
Wielbasis	2925	3275	3000	3275	3122
Overhang vooraan	881	881	975	881	975
Overhang achteraan	803	803	830	1153	1038
Vrije hoogte	150	150		150	
Spoorbreedte vooraan	1627	1627		1627	
Spoorbreedte achteraan	1600	1600		1600	
Aanvalshoek (1T versie)	17.1	17.1			
Aanvalshoek (1,4T versie)		16.8		16.8	
Vertrekhoek (1T versie)	19.9	21.1			
Vertrekhoek (1,4T versie)		21.4		15.3	



External overall height:

Guaranteed access to underground car parks limited to 1.90 m on the standard payload versions. Chassis with the increased payload mean that this access cannot be guaranteed.

VAN: Nuttige afmetingen



Updated 01/10/2015	NG	NG	CG	NG	CG
Van: afmetingen	Compact	Medium	L1	Long	L2
Afmetingen van de laadruimte					
Max. lengte op vloerniveau	2162	2512	2254	2862	2584
Max. lengte op vloerniveau (met smart cargo)	3324	3674		4026	
Lengte (half hoogte)	1835	2185		2535	
Breedte tussen de wielkasten	1258	1258	1245	1258	1245
Max. breedte	1628	1628	1600	1628	1600
Max. hoogte	1397	1397	1449	1397	1449
Volume					
Laadvolume	4.6	5.3	5	6.1	6
Laadvolume met smart cargo (Comfort)	5.1	5.8		6.6	
Aantal Euro-palettes	2	3		3	
Afmetingen van de opening achteraan					
Min. laadrempeel	545	544	562	600	562
Max. laadrempeel	626	613	604	633	604
Max. openingsbreedte	1282	1282	1237	1282	1237
Openingshoogte	1220	1220	1272	1220	1272
Afmetingen van de opening op de zijkant					
Max. openingsbreedte	745	935	924	935	924
Openingshoogte	1238	1241	1293	1241	1293
Hanteerbaarheid					
Draaicirkel tussen stoepen	11.3	12.4	12.18	12.4	12.59
Draaicirkel tussen wanden	11.8	12.9		12.9	
Massa's & aanhanggewicht					
Max. laadvermogen (van)		1400 kg	1200 kg	1360 kg	1200 kg
Nuttige lading (van)	1000 kg	1000 kg	1000 kg		1000 kg
Min. aanhanggewicht (van)	1400 kg	1400 kg		1900 kg (1600kg AT)	
Max. aanhanggewicht (van)(met aangepaste laadcapaciteit)	1800 kg	2500 kg (2.0D 120)	2000 kg	2500 kg (2200kg AT)	2000 kg

VERSO: Specifieke afmetingen



	NG	NG	CG	NG	CG
	Compact	Medium	L1	Long	L2
Buitenafmetingen					
Lengte	4606	4956		5306	
Wielbasis	2925	3275		3275	
Min. hoogte	1905	1890		1890	
Max. hoogte		1925		1935	
Afmetingen van de laadruimte					
Max. lengte (neergeklapte rugleuning vooraan)	2811	3161		3511	
Max. lengte achter de 1ste rij	2063	2413		2763	
Breedte tussen de wielkasten	1228	1228		1228	
Max. breedte	1618	1618		1618	
Max. hoogte	1334	1337		1339	
Afmetingen van de passagiersruimte					
Max. breedte (1ste rij)	1712	1712		1712	
Schoudersbreedte (1ste rij)	1515	1515		1515	
Schoudersbreedte (2de rij)	1586	1586		1586	
Schoudersbreedte (3de rij)	1570	1570		1570	
Afmetingen van de opening achteraan					
Min. hoogte van de laaddrempel	587	584		584	
Max. hoogte van de laaddrempel	610	653		664	
Max. openingsbreedte	1229	1212		1212	
Openingshoogte	1177	1181		1181	
Afmetingen van de opening op de zijkant					
Max. openingsbreedte	743	933		933	
Openingshoogte	1180	1181		1181	

VAN: Buitenafmetingen voor sticker



Afmetingen in mm

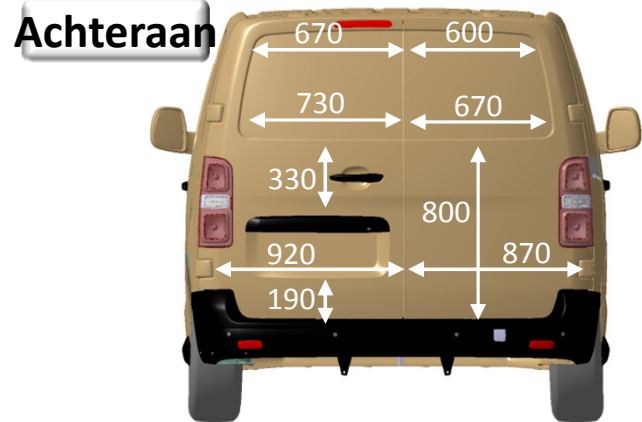
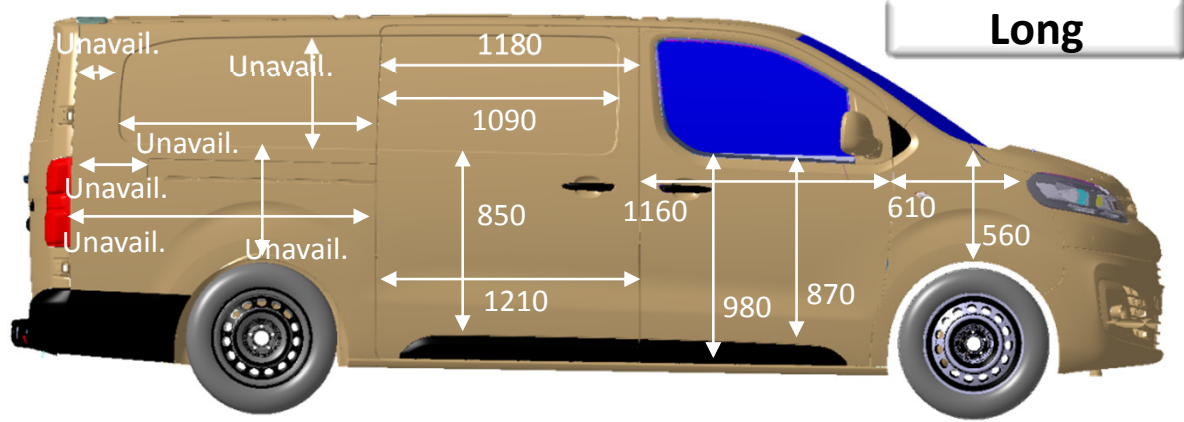
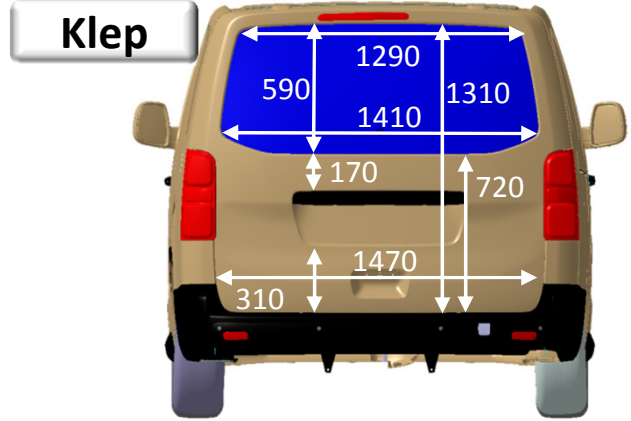
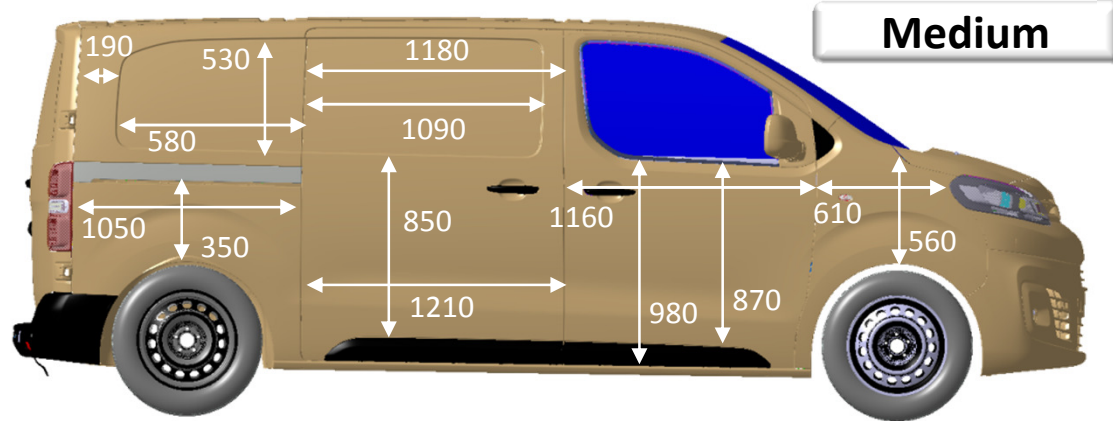
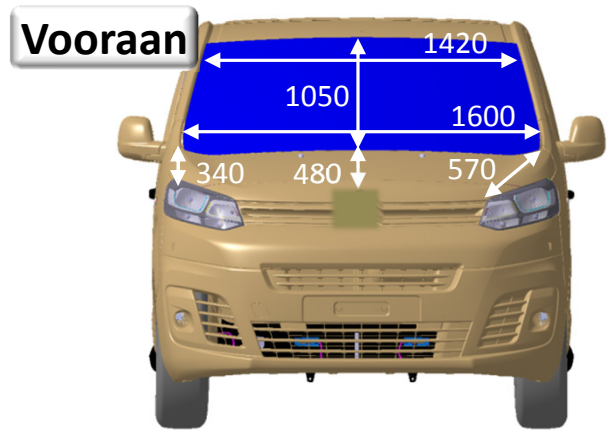
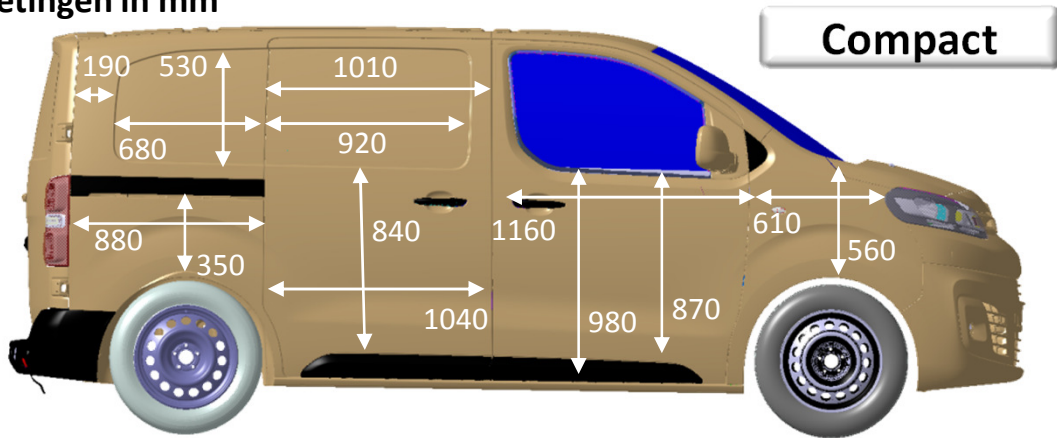

VAN & COMBI: Zetelsinrichting



Proace Van & Platform cab

→ in Compact, Medium & Long

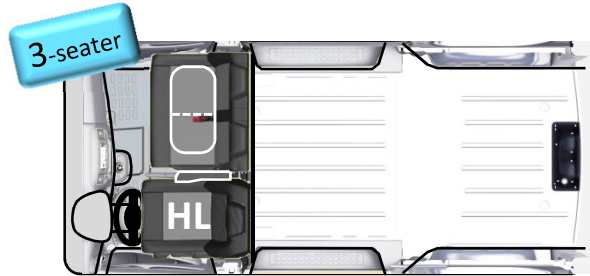

→ Pure & Active

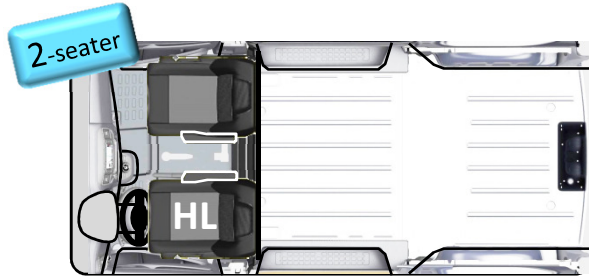

→ Gold

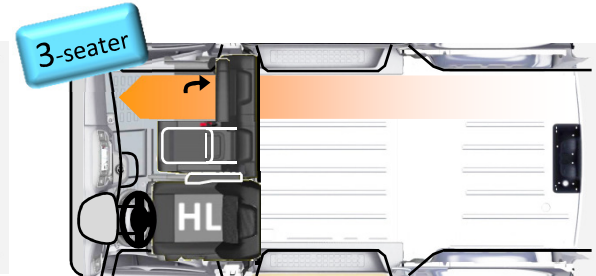

→ Smart Cargo modularity
Comfort

Proace Van Double cab

→ in Long

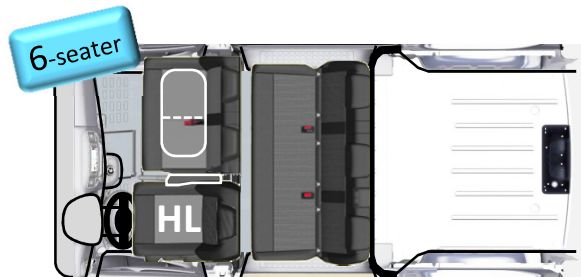

HL

Hoogteregeling & lendensteun op bestuurderszetel

Proace Combi

→ in Compact, Medium & Long



MEDIUM
LONG
COMPACT (optie)

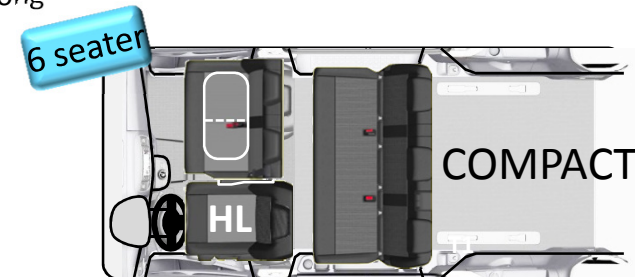

VERSO: Zetelsinrichting



Proace Verso Shuttle: Vaste zetels

→ in Compact, Medium & Long

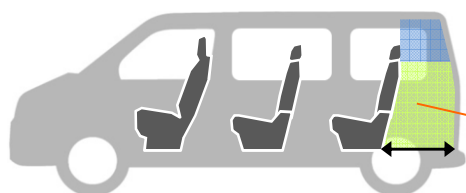
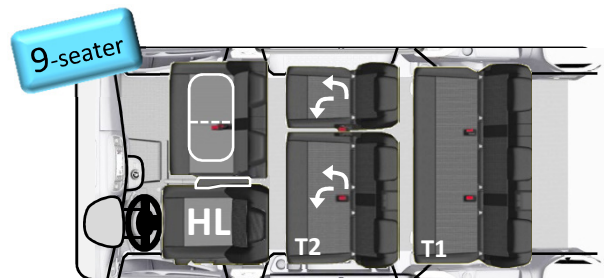

→ Vaste zetels

Volumes	Compact	Medium	Long
Hoogte tot dak	-	700 l	1300 l
Hoogte tot rugleuning	180 l	550 l	980 l
Laadlengte (vloer)	266 mm	608 mm	958 mm

Proace Verso VIP

→ in Medium & Long

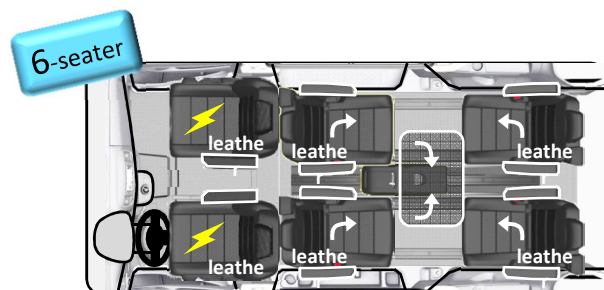

VERSO MPV: Zetelsinrichting



Proace Verso MPV

→ in Compact, Medium & Long/
→ 5 seater in Compact

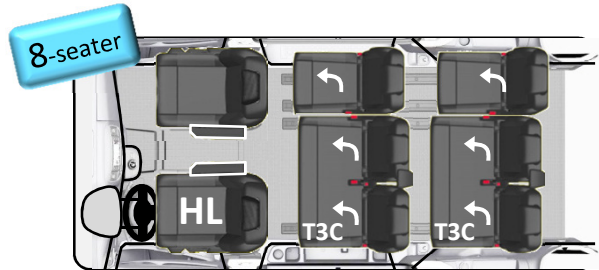

5 seater Std op Compact

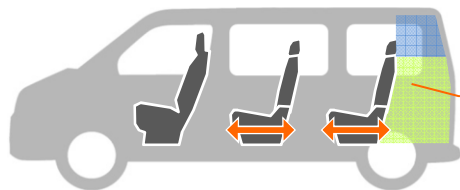

→ Zetels op rails

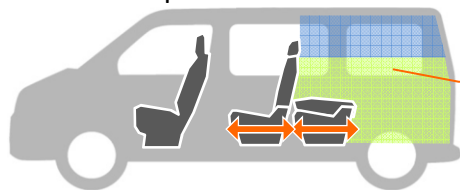

Volumes	Compact	Medium	Long
Hoogte tot dak	-	900 l	1500 l
Hoogte tot rugleuning	280 l	640 l	1060 l

Volumes	Compact	Medium	Long
Hoogte tot dak	1500 l	1950 l	2600 l
Hoogte tot rugleuning	850 l	1100 l	1500 l

VERSO MPV: Zetelsinrichting



8-seater

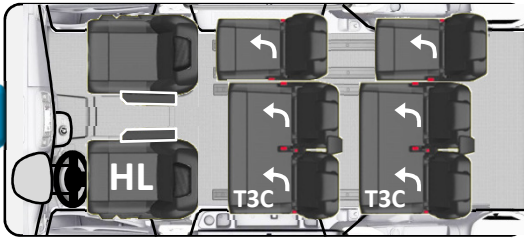

7-seater

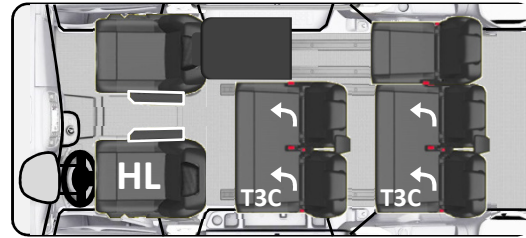
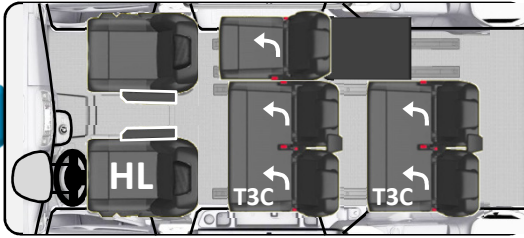

6-seater

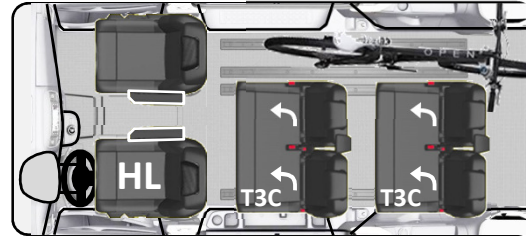
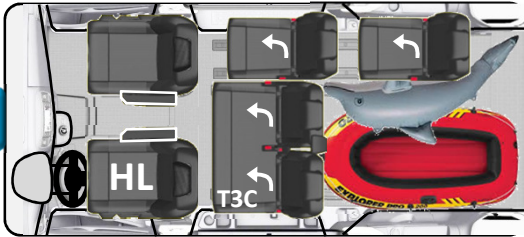

5-seater

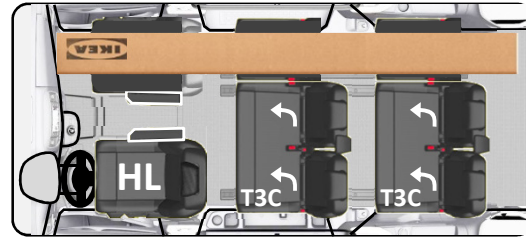
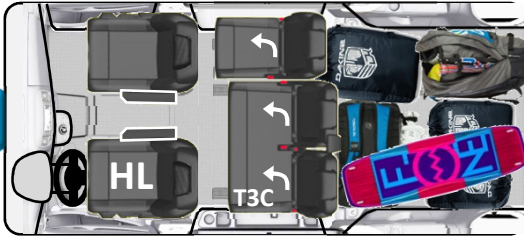

4-seater

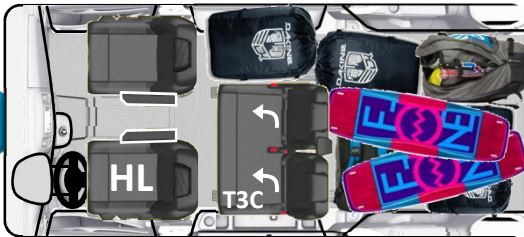

2-seater

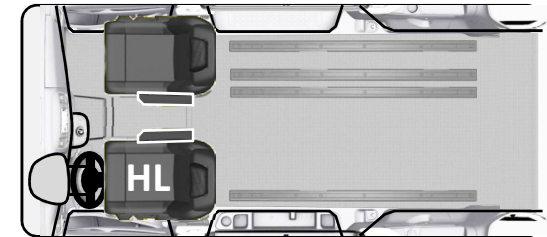

COMBI & SHUTTLE: Koffervolume (vaste zetels)



Compact

Medium

Long

8/9
sts

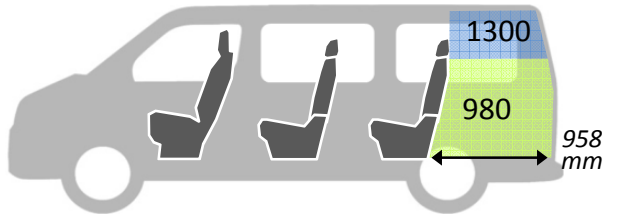
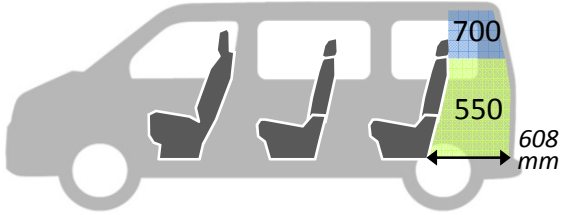

5/6
sts

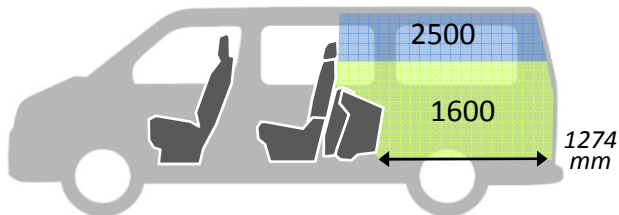
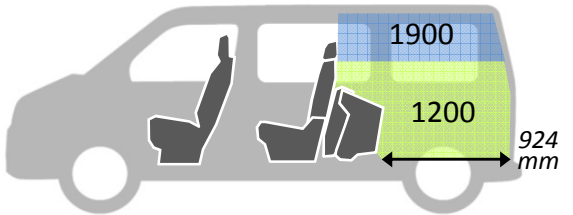
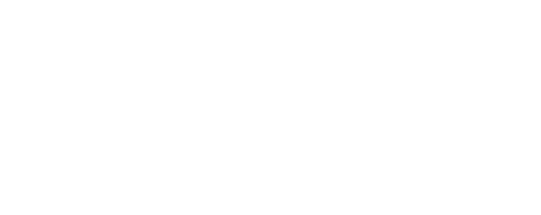

5/6
sts

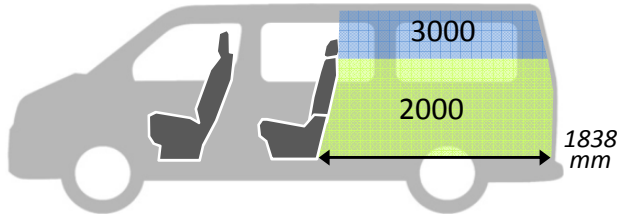
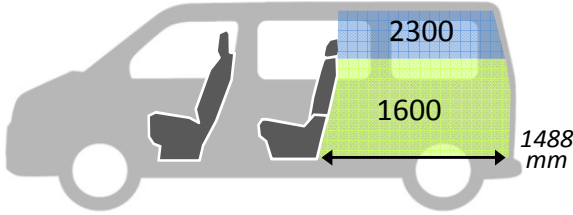
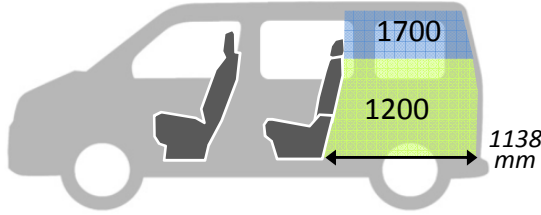

2/3
sts

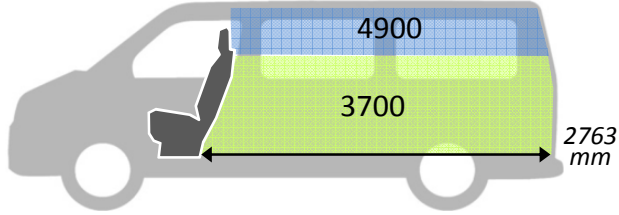
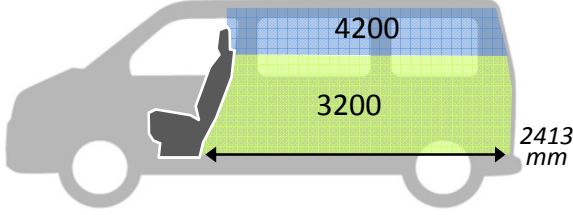
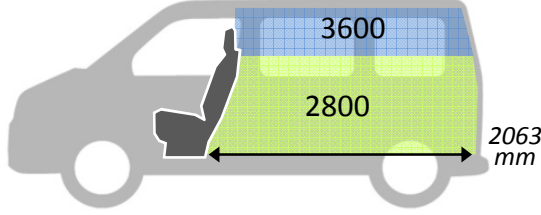

Volume hoogte rugleuning
 Volume tot dakhoogte

Volumes in litres of water

MPV: Koffervolume (zetels op rails)



Compact

Medium

Long

8
sts

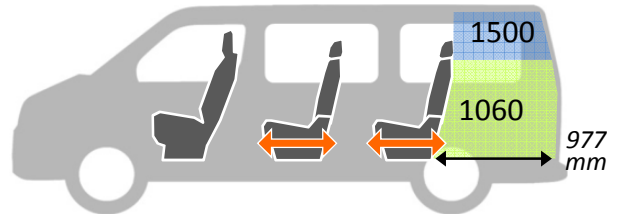
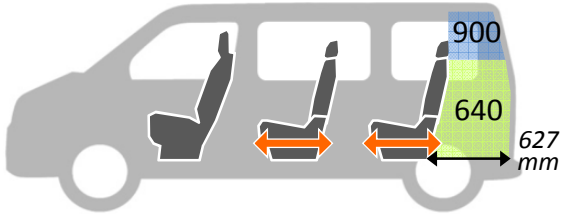
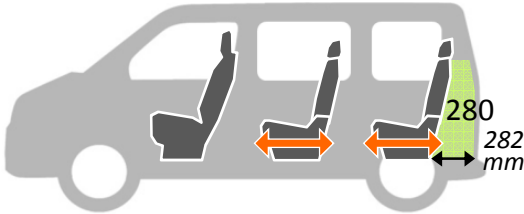

5
sts

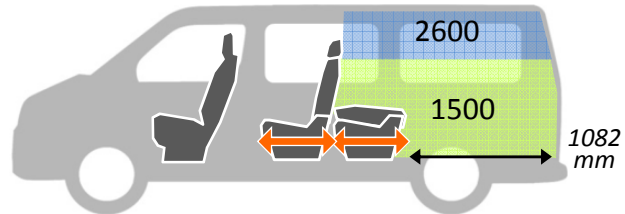
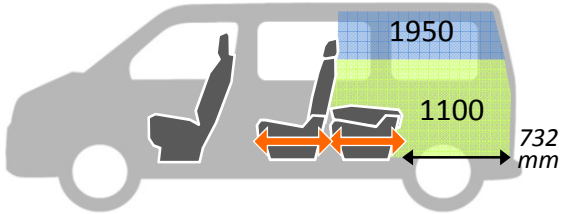
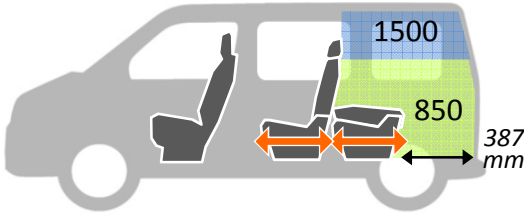

5
sts

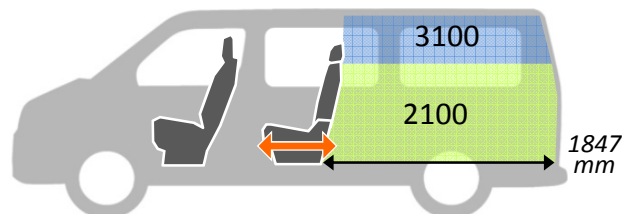
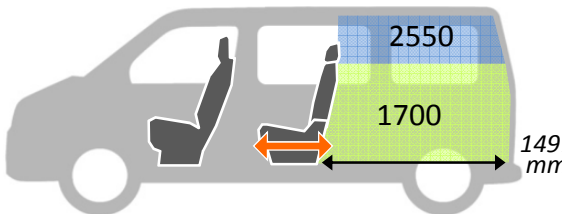
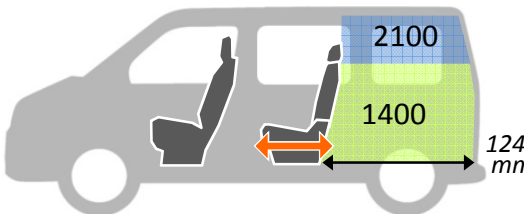

1*
2
sts

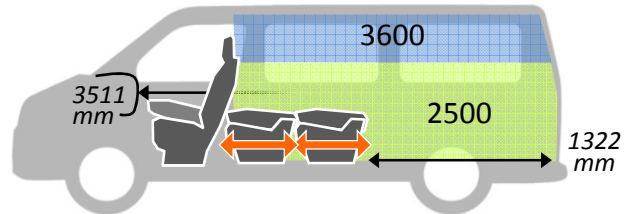
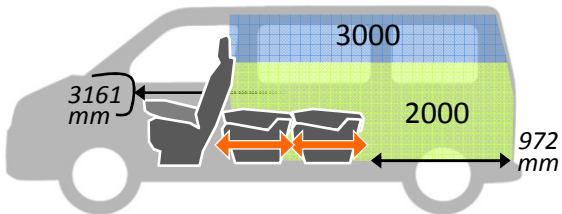
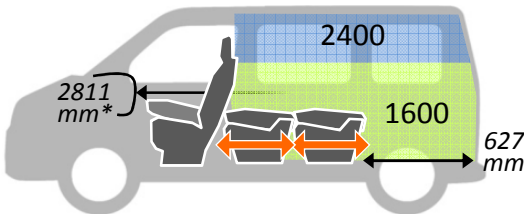

*avec dossier passager avant rabattu

2
sts

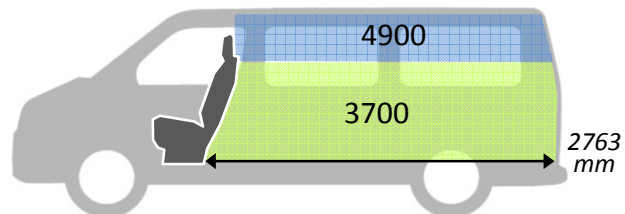
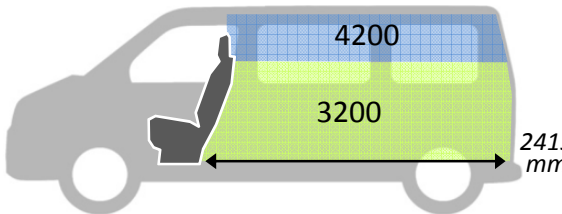
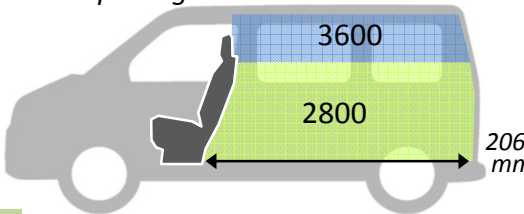

- Volume hoogte rugleuningr
- Volume tot dakhoogte

MOTORISATIES: Euro6 (VAN)



Proace VAN	1.6 D 95 MT	1.6 D 115 MT	2.0D 120MT	2.0D 150MT	2.0D 180AT
Hoogste toegelaten massa (T)	2.6* - 2.8	2.6*	3.1	2.7* - 3.1	2.7* - 3.0
*not on long					
Engine	DV6FDU	DV6FCU	DW10FE	DW10FD	DW10FC
Regulation emission standard	Euro 6.1	Euro 6.1	Euro 6.1	Euro 6.1	Euro 6.1
Capacity (cm3)	1560	1560	1997	1997	1997
Bore x Stroke (mm x mm)	75 x 88.3	75 x 88.3	85 x 88	85 x 88	85 x 88
Max. Power / engine speed (kW / rpm)	70 / 3750	85 / 3750	90 / 4000	110 / 4000	128 / 4000
Max. Torque / engine speed (Nm in rpm)	210 / 1750	300 / 1750	340 / 2000	370 / 2000	400 / 2000
Transmission	BE4/5L	ML6 V	ML6 V	ML6 V	AM6III
Final gear ratio	15/76	15/76	15/67	15/67	15/53
Vehicle speed (km/h per 1000 rpm)					
1st gear	7,17	7,54	7,54	7,54	9,53
2nd gear	13,27	14,39	14,39	14,39	16,93
3rd gear	21,43	23,54	23,54	23,54	27,3
4th gear	30,13	33,42	33,42	33,42	37,2
5th gear	37,54	41,73	41,73	41,73	49,91
6th gear	-	50,76	50,76	50,76	63,91

MOTORISATIES: Euro6 (VERSO)



Proace PC	1.6 D 95 MT	1.6 D 95 MMT	1.6 D 115 MT	2.0D 150MT	2.0D 180AT
Hoogste toegelaten massa (T)	2.6* - 2.8	2.6* - 2.8	2.6*	2.7* - 3.1	2.7* - 3.0
*not on long					
Engine	DV6FDU	DV6FDU	DV6FCU	DW10FD	DW10FC
Regulation emission standard	Euro 6.1	Euro 6.1	Euro 6.1	Euro 6.1	Euro 6.1
Capacity (cm3)	1560	1560	1560	1997	1997
Bore x Stroke (mm x mm)	75 x 88.3	75 x 88.3	75 x 88.3	85 x 88	85 x 88
Max. Power / engine speed (kW / rpm)	70 / 3750	70 / 3750	85 / 3750	110 / 4000	128 / 4000
Max. Torque / engine speed (Nm in rpm)	210 / 1750	240 / 1750	300 / 1750	370 / 2000	400 / 2000
Transmission	BE4/5L	MCP	ML6 V	ML6 V	AM6III
Final gear ratio	15/76	14/71	15/76	15/67	15/53
Vehicle speed (km/h per 1000 rpm)					
1st gear	7,11	6,9	7,54	7,54	9,53
2nd gear	13,16	12	14,39	14,39	16,93
3rd gear	21,24	18,5	23,54	23,54	27,3
4th gear	29,87	27,1	33,42	33,42	37,2
5th gear	37,21	35	41,73	41,73	49,91
6th gear	-	43,8	50,76	50,76	63,91

MOTORISATIES: CO2 uitstoot & verbruik (VAN)



CO2 emissions and cons. in mixed cycle. Data of 12 February 2016.

Values on a grey background are those of versions which have not yet been approved. These values can nonetheless be published in catalogues, specifying "subject to approval".

Euro 6		Pmax (kW)	Cmax (Nm)	Versions 2ppl						Versions 3ppl					
				Compact		Medium		Long		Compact		Medium		Long	
				std	max	std	max	std	max	std	max	std	max	std	max
1.6 D 95 MT		70	210							144		144			
1.6 D 115 MT S&S		85	300							133		137			
2.0 D 120 MT S&S		90	340									139		139	
2.0 D 150 MT S&S		110	370			139						139		139	
2.0 D 180 AT S&S		130	400											155	
Euro 6		Pmax (kW)	Cmax (Nm)	Compact		Medium		Long		Compact		Medium		Long	
				std	max	std	max	std	max	std	max	std	max	std	max
1.6 D 95 MT		70	210							5,5		5,5			
1.6 D 115 MT S&S		85	300							5,1		5,2			
2.0 D 120 MT S&S		90	340									5,3		5,3	
2.0 D 150 MT S&S		110	370			5,3						5,3		5,3	
2.0 D 180 AT S&S		130	400											5,9	

MOTORISATIES: CO2 uitstoot & verbruik (VERSO)



CO2 emissions and cons. in mixed cycle. Data of 12 February 2016.

Values on a grey background are those of versions which have not yet been approved. These values can nonetheless be published in catalogues, specifying "subject to approval".

These CO2 and cons. values do not depend on the number of seats with which the vehicle is actually equipped, but on the max. number of seats for which it is approved: 6 (VIP), otherwise 8 or 9.

Versions concerned:

Proace Combi with row 1 only, row 1 + row 2 and row 1 + row 2 + row 3
 Proace Verso with row 1 + row 2 and row 1 + row 2 + row 3, but without VIP armchairs.

Versions concerned:

Proace Verso with VIP armchairs in row 3 and/or row 2

VIP Versions 6ppl (2+2+2)

Euro 6		Pmax (kW)	Cmax (Nm)
1.6 D 95 MT		70	210
1.6 D 95 MMT S&S		70	240
1.6 D 115 MT S&S		85	300
2.0 D 150 MT S&S		110	370
2.0 D 180 MT S&S		130	400

Versions 8ppl (2+3+3)					
Compact	Medium		Long		
std	std	max	std	max	
		139			
133		137			
				143	
				155	

Versions 9ppl (3+3+3)					
Compact	Medium		Long		
std	max	std	max	std	max
144		148		148	
137		137		137	
139		139		143	

Compact	Medium		Long		
std	max	std	max	std	max
				147	
		159		159	

Euro 6		Pmax (kW)	Cmax (Nm)
1.6 D 95 MT		70	210
1.6 D 95 MMT S&S		70	240
1.6 D 115 MT S&S		85	300
2.0 D 150 MT S&S		110	370
2.0 D 180 MT S&S		130	400

Compact	Medium		Long	
std	std	max	std	max
		5,4		
5,1		5,2		
				5,5
				5,9

Compact	Medium		Long		
std	max	std	max	std	max
5,5		5,6		5,6	
5,2		5,2		5,2	
5,3		5,3		5,5	

Compact	Medium		Long		
std	max	std	max	std	max
				5,6	
		6,0		6,0	

VAN: Dubbele cabine



Dubbele cabine

→ Voor de professionele beroepen die 3 extra passagiers moeten vervoeren (6 plaatsen aan boord), met de voordelen van een lichte vracht en een zeer ruime laadvolume.

Gebaseerd op de Van LONG, in 2 afwerkingniveaus.

→ De dubbele cabine ombouwing wordt ontwikkeld in medewerking met de Europese specialiste ter zake: SNOEKS.

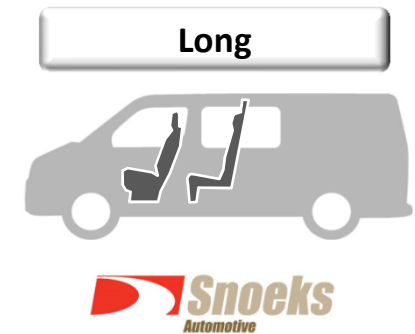

Volume

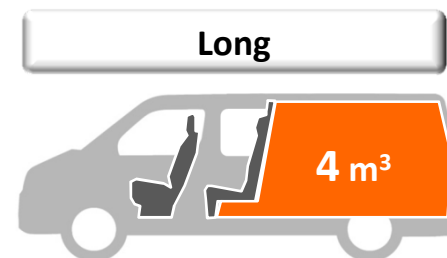

VAN: Dubbele cabine



Vaste tussenschot met ruit

Beschikbaar in 2 uitvoeringen:

ACTIVE:

Ontwikkeld op de basisversie, met zijpanelen in Isorel, staalplaat afwerking, anti-slip houten vloer (voor passagiers achteraan).

COMFORT:

Bovenops:

- Stoffen zetelbekleding, "Shuttle" zijkant afwerking, regelbare hoofdsteunen,
- Een opbergruimte van 90-liter onder de zitbank .
- Een USB-aansluiting voor passagiers achteraan
- ISOFIX op de 2 laterale zetels.

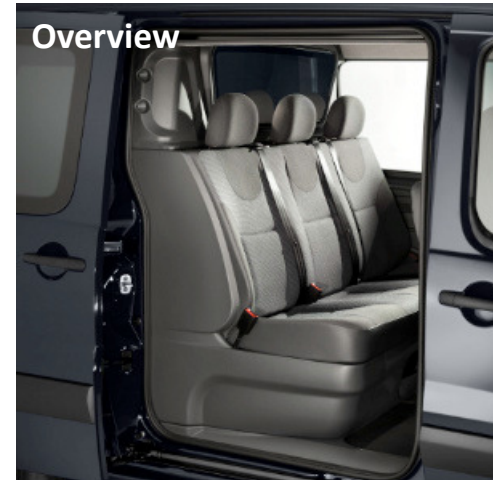

VAN Dubbele cabine: Afmetingen



	NG	NG		NG	CG
Double Cabine	Compact	Medium		Long	L2
Afmetingen van de laadruimte					
Max. lengte op vloerniveau				2365	1700
Lengte (half hoogte)				1700	
Max. breedte				1618	1602
Max. hoogte				1339	1449
Max. hoogte onder de zitbank				232	
Volume					
Max. volume				4	3,6
Max. volume van de opbergruimte onder de zitbank				90,1 L	
Max. lengte van de opbergruimte onder de zitbank				490	
Afmetingen van de opening op de zijkant					
Max. breedte				935	924
Max. hoogte				1181	1293
Massa's					
Max. laadvermogen				1185	1200



Van & Verso	Arctic White (EWP) Non-metallic colour	Atonium Silver (EZR) Metal colour	Falcon Grey (EVL) Metal colour	Grey Limestone (NEU) Metal colour
	Martinique Blue (KNP) Non-metallic colour	Sicily Black (EXY) Non-metallic colour	Rich Brown (KCM) Metal colour	Carnelian Orange (KHK) Metal colour
	Exclusieve Van kleur	Sevilia Red (KJF) Non-metallic colour	Op Comfort, deurgrepen en spiegels in zwart	

Specifiek op Comfort / Gold / Shuttle / MPV / VIP:
→ Buitenspiegels in koetswerkkleur
→ Deurgrepen in koetswerkkleur